



▶ **Hydraulic System Test Analyzers**
Installation, Operating &
Maintenance Manual

Technical Specifications

Measuring Accuracy

Flow: $\pm 2\%$ of full scale

Pressure: $\pm 2.5\%$ of full scale

Temperature: $\pm 2.5\%$ of full scale

Repeatability

$\pm 1\%$ of full scale - all measurements

Flow Measuring Range

Flow: 0.1-150 GPM (0.5-550 LPM)

Temperature: 0-250°F (-20-120°C)

Maximum Operating Temperature

240°F (116°C)

Maximum Operating Pressure

Aluminum meters:

3000 PSIG (200 Bar)

Stainless steel meters:

5000 PSIG (340 Bar)

Standard Calibration Fluid

Oil meters: DTE 25® @ 110°F (43°C), 0.873 sg

Filtration Requirements

74 micron filter or 200 mesh screen minimum

Viscosity

Standard viscosities up to 110 cSt

DTE 25 is a registered trademark of Exxon Mobil.

Materials of Construction

Wetted Components		Non-Wetted Components	
Component	Materials	Component	Materials
Needle Valve	Carbon Steel	Window Tube	Polycarbonate
Casing and End ports	Anodized Aluminum (3000 PSIG) Stainless Steel (5000 PSIG)	Window Tube Seals	Buna-N®
Seals	Buna-N® (STD), FKM, EPR, Neoprene optional	Gauge	Brass and Stainless Steel
Transfer Magnet	PTFE coated Alnico	Gauge Window	Acrylic
All other internal parts	Stainless Steel		

Buna-N is a registered trademark of Chemische Werke Huls.

Introduction

A properly designed and maintained hydraulic system will perform dependably under extreme conditions, but as its components begin to wear overall efficiency of the system will suffer. This loss of efficiency in various components can place a strain on the entire system resulting in pressure changes & higher oil temperatures which tend to jeopardize the lubricating properties of oils. The other issue that results from improperly operating hydraulic systems with excessive wear and/or contamination is the increased energy consumption that can be expected.

The Troubleshooting Problem

Because a loss of efficiency can be attributed to a variety of individual component failures, a systematic approach to troubleshooting will more positively locate the source of the failure. Simply replacing system components on a trial and error basis will waste time and money. Generally, the ideal method for diagnosing and servicing hydraulic systems involves testing the most costly components first while repairing or replacing the least costly components as a result of the outcome of these tests.

The Troubleshooting Solution

To assure the proper operating characteristics of hydraulic system components, we offer its proven products and a 5-Step Method to systematically perform hydraulic troubleshooting.

WARNING: The Analyzer and troubleshooting method are designed to be general in nature and require a knowledgeable user to identify system components and have an understanding of system operating characteristics. Use by non-qualified personnel can lead to serious system damage and/or personal injury.

WARNING: Never hit a flow meter or empty fluid with full fluid flow. This fluid shock or hammering effect on the internals of the flow meter can permanently damage the internal components.

The heart of AW-Lake's troubleshooting method is the Hydraulic System Analyzer. (See Illustration 1) The Analyzer provides direct indication of flow rate, system pressure

Illustration 1 - System Analyzer

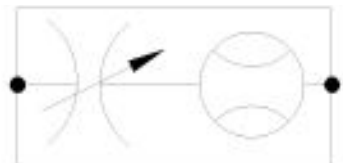

and temperature*. It also has an integral load valve that is adjusted during the troubleshooting process.

**The T-series of products offers temperature, flow and pressure indication, whereas the K-series offers flow & pressure alone.*

Step 1 - Basics

Before any extensive troubleshooting procedures are started, the following several items need to be considered:

- Ensure that the suction strainer, which is located either in the line between the reservoir and pump or inside the reservoir, is clean. Restrictions in the pump's suction line will cause pump cavitations and loss of high pressure and can cause excessive pump noise and premature wear.
- Ensure that the suction line within the reservoir is covered with at least 3" of oil. Failure to maintain a flooded suction line can also lead to the conditions stated above.
- Make an effort to obtain all product data sheets and specifications for the equipment to be tested. Having this information at hand will help during the diagnosis.
- Most importantly, study and apply the applicable safety guidelines for the equipment being tested. Apply best practices and avoid damage to equipment or personal injury.

Step 2 - Pump Output

To measure the hydraulic horsepower that is being generated by the system's pump, the System Analyzer should be plumbed directly in-line after the system's pump outlet and relief valve. **Be sure to orient the Analyzer so that its flow direction arrow corresponds with the actual flow direction.**

Open the flow control valve on the Analyzer fully counter clockwise, start the system and bring the oil temperature to standard operating temperature.

Illustration 2

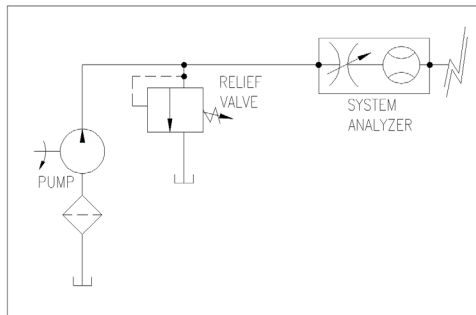

With the pump operating at the RPM recommended by the manufacturer, note the flow rate indicated on the Analyzer. Adjust the load valve on the Analyzer clockwise until the pressure indicated on the Analyzer is just below the relief valve setting. Note the flow rate on the Analyzer. An indication lower than what is specified by the pump manufacturer as an acceptable margin or a drop of more than 10% in flow rate (flow rate under pressure/flow rate at no pressure = less than 0.9) indicates a need for pump service.

Step 3 - Relief Value

To test for proper operation of the system's relief valve, install the Analyzer immediately downstream from the valve ensuring proper orientation of the Analyzer. **(See Illustration 2)**

Open the valve on the Analyzer fully counter clockwise, start the system and allow it to run until it reaches its normal operating temperature as dictated by the manufacturer supplied data.

With the pump operating at the RPM recommended by the manufacturer, gradually close the Analyzer's load valve noting the pressure that the flow rate drops off at. If that pressure differs from the system's design pressure, the valve may need to be cleaned, adjusted or replaced.

This point of the procedure requires that the data from the equipment manufacturer calls out a set point and/or an acceptable range of tolerance for the relief valve. Often times this information can be found on a label or tag on the valve or pump housing.

Step 4 - Testing Hydraulic Cylinder Leakage

If the results of Steps 1 – 3 are acceptable, the problem lies down stream from those components. One common source of poor system performance can be faulty seals in hydraulic cylinders. To test the cylinder's seals, make certain the cylinder is not under any mechanical load and that the ram or piston rod is completely unobstructed.

Generally, it is recommended that the reverse flow capable variation of analyzers is used to diagnose cylinder leakage as this will make the tests simpler and compliment the bi-directional nature of the flows to and from the cylinder. This being stated, the standard analyzer product is not capable of reverse flow and the misuse of the product will result in damage to the analyzer and/or the system under test that is not covered by the warranty.

Run the piston to one end of its stroke and leave it stalled in this position and power down the system. Plumb the analyzer into the line at the end of the cylinder in which the piston is resting, orient the flow arrow toward the directional valve. **(See Illustration 3)**

Fully close the Analyzer's load valve by turning it completely clockwise. Power up the system and actuate the directional valve so that the piston remains stalled under pressure. Do not actuate in the reverse direction unless your analyzer part number includes an -RF at the end (reverse flow capable). Now check the pressure gauge on the Analyzer. If pressure exists open the valve for a moment and close it again. If pressure returns, the cylinder is leaking.

Illustration 3

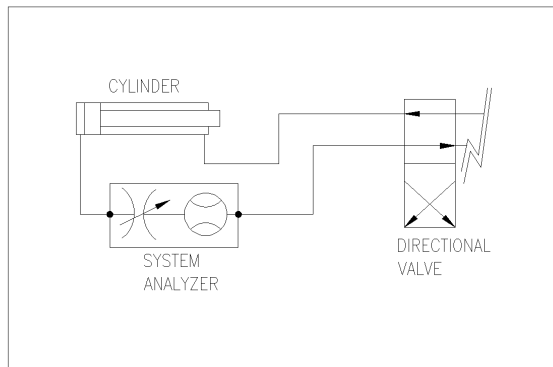
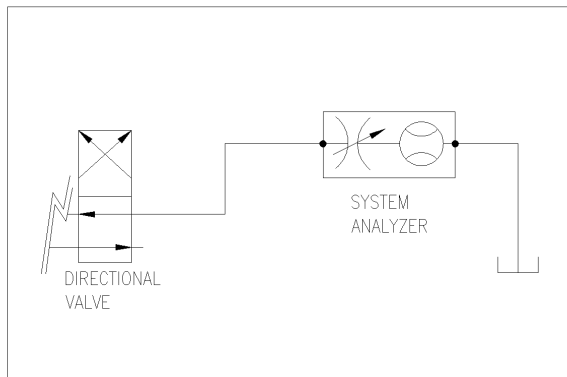

Illustration 4



Step 5 - Directional Control Valve

To test for leakage in a directional control valve, disconnect the flow line exiting the control valve and connect the line to the inlet of the Analyzer. Connect the outlet of the Analyzer to a line returning to the reservoir. (See Illustration 4) Fully open the Analyzer's load valve by turning it completely counter clockwise. Start the system's pump and allow the oil to reach proper operating temperature.

To test the valve, shift the valve to allow flow to pass through the Analyzer. Operate the system's pump at its rated RPM - note the flow rate indicated on the Analyzer. Gradually increase the system pressure by turning the Analyzer's load valve clockwise until system pressure is just below the relief valve setting. Note the indicated flow rate. If the flow rate has dropped more than it did in Step 2, the valve needs servicing.

Troubleshooting & Maintenance

TROUBLESHOOTING CHART	
Malfunction: Magnet follower sticks in mid-scale and will not return to the “no flow” position.	
<p>Possible Cause: <i>Horizontal/Vertical Mount</i> Particulate, thread seal tape, rust or other foreign matter is holding the internal parts from returning.</p> <p>Horizontal/Vertical Mount A surge or shock in the fluid flow moved the internal magnet faster than the external follower could follow, thus separating the follower from the magnet.</p>	<p>Corrective Action: Disassemble and inspect meter for contamination. Install proper filtration or problem may reoccur.</p>
<p>Warning: Shut down systems before removing meter from flow line. Remove meter from system. Tip the meter so the arrow on the flow scale points upward. This should return the magnet follower to the “no flow” position. Add some type of surge protection, or problem may reoccur.</p>	
Malfunction: Meter scale reading is off an equal amount at all points and the magnet follower still moves freely.	
<p>Possible Cause: Reading the scale using the top or bottom edge of the magnet follower.</p>	<p>Corrective Action: Be sure to read the scale using the black reference line which runs around the magnet follower.</p>
<p>Possible Cause: Fluid being monitored may not be compatible with standard meter scale.</p>	<p>Corrective Action: Standard meters are calibrated for .873 SG. Gr oil at 110° F (43°C), Water 1.0 SG at 70°F (21°C) and Air 1.0 SG at 70°F (21°C) at 100 PSI. Check your fluid data for variance, or call the factory for assistance.</p>
<p>Possible Cause: All meters are calibrated in the horizontal position.</p>	<p>Corrective Action: Check with the factory for a correction factor or for a replacement scale corrected for vertical use.</p>

TROUBLESHOOTING CHART (CONTINUED)

Malfunction: Window tube is cracking or crazing.	
Possible Cause: Using incompatible cleaning solution on Lexan window tube.	Corrective Action: Use soap & water or a mild degreaser (Stoddard or Naptha) to clean Lexan tube. To check the compatibility of your cleaning fluid, call General Electric's Lexan Compatibility Reference line at 800-845-0600.
Malfunction: Scale is fogging or coming loose.	
Possible Cause: Ambient or fluid temperature is above meter specifications.	Corrective Action: Relocate meter in another area where temperature specifications are not being exceeded.
Possible Cause: Using incompatible cleaning solvents on scale.	Corrective Action: Use soap and water.

Disassembly

Important: It is not necessary to remove window tube or window seals to clean the meter. Note also how the meter disassembles for ease of reassembly.

Warning: Shut down system before removing meter from flow line.

1. Use a clean dry cloth to remove all foreign material from exterior of meter, especially around threaded ends.
2. Remove meter from the flow line.
3. With the arrow on the scale pointing upward, mount the meter in a vice. See **Illustration 3**. Use the flats of the

Illustration 3

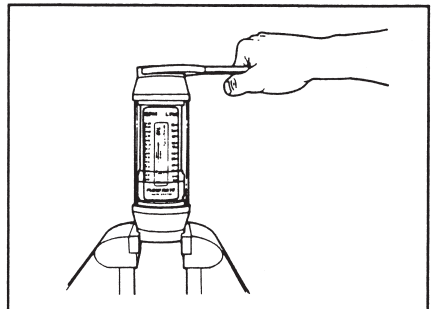

inlet end porting when securing the meter in the vice. **Important:** DO NOT wrench or tighten vice on Lexan tube.

4. Install a wrench across the flats of the outlet end porting and turn counterclockwise to loosen assembly. Do not remove end porting at this time.
5. Remove meter from vice. Hold the meter so the end port that is loose, is on top. Remove loose end porting.
6. Tilt the open end of meter over a clean cloth to expose inner cartridge. See **Illustration 4**.

Illustration 4

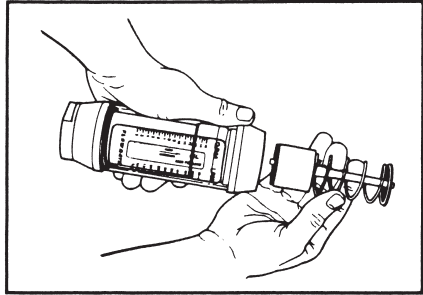

Remove inner cartridge assembly from body casing. Note: Because the transfer magnet is magnetically coupled to the magnetic follower, you will notice a slight resistance when removing cartridge. If cartridge does not slide out, insert a wooden dowel in opposite end of meter and push or lightly tap on dowel until cartridge comes loose.

IMPORTANT: If inner cartridge does not slide out freely, it may be sign of contamination. The transfer magnet is a powerful ALNICO magnet. Keep it away from metal chips and fillings. They may be hard to remove when reassembling and will cause premature failure.

7. Examine inner cartridge or level of contamination.
 - A. If inner cartridge has a low level of contamination and is functioning properly, no further disassembly is required. Proceed to “Cleaning and Inspection.” See **Illustration 5**.
 - B. If inner cartridge appears to be highly contaminated or damaged, it should be completely disassembled for cleaning and inspection. Proceed with Step 8.

Illustration 5

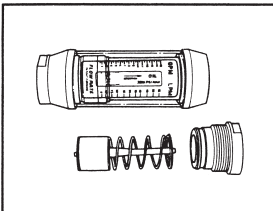
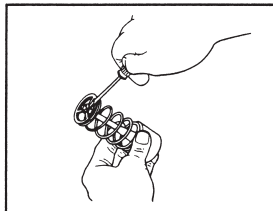

Illustration 6



8. Remove outlet side (spring end) retainer clip, See **Illustration 6**, which secured pilot disk to tapered center shaft.

1. Remove return spring, transfer magnet and floating orifice disk. See **Illustration 7**.

Illustration 7

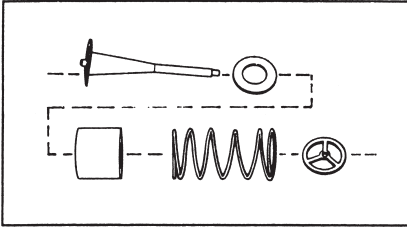

2. Proceed to "Cleaning and Inspection." After the meter is cleaned reassemble parts in reverse order of disassembly.

IMPORTANT: Always use new retainer clips for reassembly. 3/8" and 1/2" = Waldes No. 5105-12H. 3/4 and 1" and 1-1/4" and 1-1/2" = Waldes No. 5105-18H, or obtain at no charge from the factory.

Cleaning and Inspection

Note: If the inner cartridge is damaged or contaminated beyond repair, the complete meter can be sent to the manufacturer for evaluation. The manufacturer will repair or replace parts as needed.

1. Inspect inner cartridge and body casing for contamination. If the inner cartridge did not slide out freely, it may be a sign of contamination. Locate and eliminate the source of contamination before reconnecting meter to the system or the same problem will reoccur. It may be necessary to install finer filtration or a magnetic filter in the system.
2. Soak inner cartridge assembly (or individual parts, depending on level of disassembly) in a suitable cleaning solvent. Naptha or Stoddard is recommended.

CAUTION: When using an air hose wear proper eye protection.

3. Remove parts from solvent. Use an air hose and/or scrub with a light brush to remove any remaining contaminants. Remove any magnetized particles from transfer magnet.
4. Inspect inner cartridge for scored or worn parts. Replace parts as needed. (Parts are available from your local distributor.)
5. Remove any contaminants from inside body casing.
6. Clean Lexan window tube with soap and water, or a compatible cleaning

solvent. **IMPORTANT:** Some solvents may cause damage to Lexan tube, check compatibility of solvent being used.

7. Clean and inspect seal assemblies (O-rings and seals) for nicks or cuts. Replace as needed.
8. Clean and inspect the meter every six months.

Properly filtered meters will provide years of trouble-free service. If the meter is not properly filtered, it may be damaged and malfunction. Meter damage caused by excessive contamination is not covered under warranty.

Contamination and Filtration

Recommended Filtration

The manufacturer recommends system filtration of at least 74 micron filter or a 200 mesh screen. It has been found that if inadequate filtration has caused meter failure, it will normally fail in the open position. Some systems may require a magnetic filter. **IMPORTANT:** Meter damage caused by excessive contamination is not covered under warranty.

Stabilized Contamination

The goal of filtration is to create effective protection from system contamination. Proper filtration stabilizes contamination to allow fluid components to function properly. A fluid system is considered stabilized when, “contamination in” equals “contamination out”. Proper filtration must reduce initial contamination to a stabilized level within an acceptable time period. The system should be stabilized in time to prevent premature wear or damage to meter components.

Contamination Sources

Fresh Fluid

When fresh fluid is stored in holding tanks, it may be contaminated with scale or metal flakes from inside the tank. To prevent this type of contamination, be sure to filter fresh fluid before adding to the system.

New Machinery Contamination

When building new machines, a certain amount of built-in contamination is unavoidable. Typical built-in contamination consists of dust, dirt, chips, fiber, sand, flushing solutions, moisture, weld splatters and pipe sealants. Flushing the system before operation can reduce contamination, but cannot eliminate it totally.

Unless the system is flushed at a high velocity, some contamination will not be dislodged until the system is in operation. System contamination can cause fluid component malfunction.

Environmental Contamination

When performing routine maintenance, the system's fluid is commonly exposed to environmental contamination. Exercise caution during routine maintenance to prevent this type of contamination. Be sure to change breather filter and systems air filter regularly.

Self-Generation Contamination

Self-generated contamination is a product of wear, cavitation, fluid breakdown and corrosion. Systems that are carefully flushed, maintained, and have fresh fluid added, mainly have self-generated contamination. In this case, proper filtration can prevent fluid component malfunction.



414.574.4300 | www.aw-lake.com
2440 W. Corporate Preserve Dr. #600, Oak Creek, WI 53154